

# RCS® Pull Cable and RCS® Hand Brake Lever

## RCS® Pull Cable

RCS® Pull Cable for Brake Calipers DV 020 FKM and DH 020 FKM as well as DV 020 MKM and DH 020 MKM are available in variable cable lengths.

Cable ends are designed for attachment to Brake Calipers or RCS® Hand Brake Lever B 50452.

### Features

- Slide ease
- Stainless steel inner member wrap
- Suitable for small bending radii
- Galvanized steel elements
- Stainless steel drawbar

An extensive product range of RCS® Remote Control Systems can be found in the "RCS® Remote Control Systems" catalogue.

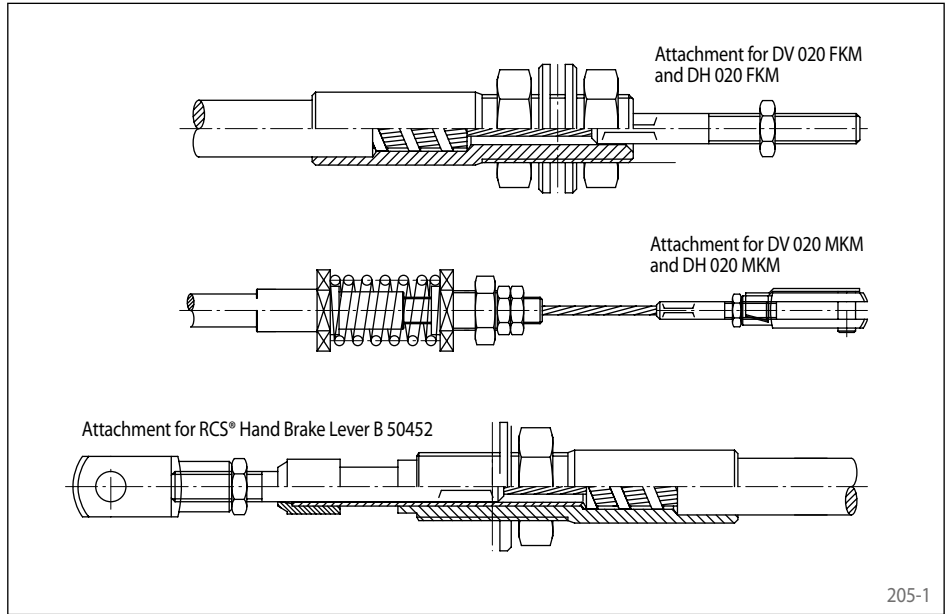

205-1

## RCS® Hand Brake Lever B 50452

The RCS® Hand Brake Lever B 50452 is used to operate Brake Calipers DV 020 FKM and DH 020 FKM as well as DV 020 MKM and DH 020 MKM in connection with a RCS® Cable.

Article Number: 4561-000001-R50452

### Features

- Two positions: "open" or "closed"
- Over center locking
- Friction Block Wear compensation
- Attachment for RCS® Pull Cables
- Optional with electric switch (Closer or Opener) available

An extensive product range of RCS® Remote Control Systems can be found in the "RCS® Remote Control Systems" catalogue.

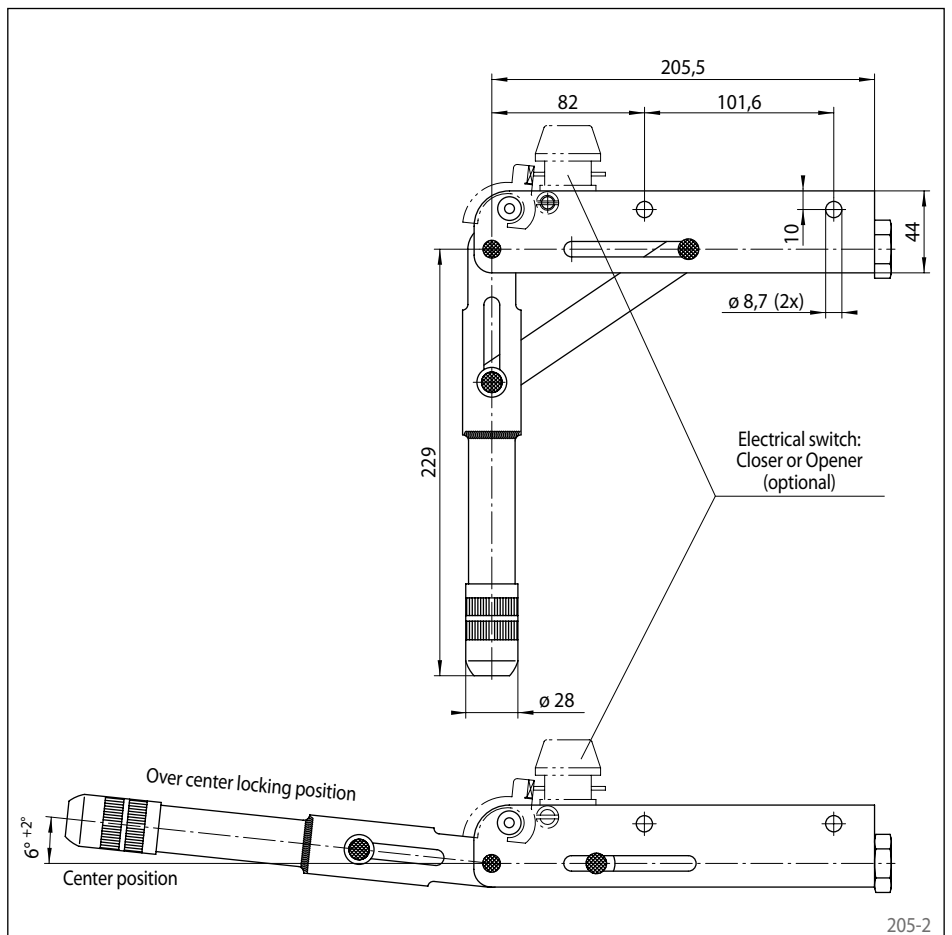

205-2